

OPERATING INSTRUCTIONS
AND
MAINTENANCE MANUAL
S-SCORT® Model 2300 Suction Series

(Model 2315 excluded)

**S-SCORT new-Duet®
Model 2314 Series
AC Suction with Battery Back-up**



**S-SCORT VX-2®
Model 2310 Series**

**New Generation S-SCORT Suction
for Prehospital Care**



**S-SCORT EVX™
Model 2309 Series**



SSCOR, INC.

11064 Randall Street • Sun Valley, CA 91352 • USA

Telephone +1-818-504-4054 • 800-434-5211

Fax +1-818-504-6032

www.sscor.com

Email: marketing@sscor.com



Caution-Notice - All Units

1. S-SCORT® suction units are not designed or intended for use in extended procedures that require prolonged high vacuum/low airflow applications, as is the case in wound drainage or endoscopic use or in any other procedure that produces high vacuum levels within an occluded system for an extended period of time. Turn the S-SCORT suction unit off when it is not in use.
2. Federal law restricts this device to sale, distribution, and use by, or on the order of a physician, emergency medical technician, or other medical practitioner. For use by medical personnel trained in suctioning techniques and in the use of medical suction equipment.
3. This manual is restricted to the discussion of the use and maintenance of this device. It does not attempt to discuss professional techniques in suctioning procedures.
4. Operator should be thoroughly familiar with these operating instructions before this device is used.
5. Reconnect all SSCOR suction units to the charging source after each use.
6. Do not use in the presence of flammable agents or anesthetics.
7. The shut-off valve in the canister lid will close down when the canister is full.
8. Install a new canister before testing for vacuum over -300mmHg to minimize the possibility of implosion, which can occur when a canister is aged or damaged.
9. External equipment intended for connection to signal input, signal output or other connectors, shall comply with relevant IEC standard (e.g. IEC 60950 for IT equipment and the IEC 60601 series for medical electrical equipment). In addition, all such combinations –systems – shall comply with the standard IEC 60601-1-1, safety requirements for medical electrical systems. Equipment not complying with IEC 60601 shall be kept outside the patient environment, as defined in the standard. Any person who connects external equipment to signal input, signal output or other connectors has formed a system and is therefore responsible for the system to comply with the requirements of IEC 60601-1-1. If in doubt, contact qualified technician or your local representative.

Caution-Notice - Model 2314 Series Only

10. Where the integrity of the external protective earth conductor arrangement (ground) is in doubt, the unit shall be operated from its internal electrical power source (battery only). Grounding reliability can only be achieved when connected to an equivalent receptacle marked “Hospital Only” or “Hospital Grade”.

Caution-Notice - Model 2314 and 2310 Series Only

11. The battery is protected from a deep discharge condition by shutting down after approximately 45 minutes ($\pm 10\%$) running time.
12. To discern the condition of the battery when the unit is disconnected from the power source, turn the unit on and observe the battery condition indicator lights on the control panel.

Caution-Notice - Model 2309 Series Only

13. SSCOR's battery charger (#80533) charges batteries only. The battery charger will not run the pump. The Model 80529 battery charger will charge the batteries and run the pump from an AC power source.

Table of Contents

| | |
|--|---------|
| Caution-Notice | 2 |
| General Description | 3 |
| Description of Symbols | 4 |
| Getting Acquainted | 5 - 8 |
| General Specifications & Trouble Shooting | 9 |
| Internal Access for Electrical and Pneumatics | 10 |
| Warranty | 11 |
| Maintenance, Sanitation and Decontamination Instructions | 12-13 |
| Declaration of Conformity | 14 |
| Retention Bracket Mounting Instructions (Model 2314 Series) | 15 |
| Retention Bracket Mounting Instructions (Model 2310 & 2309 Series) | 16 - 17 |

General Description - All Units

S-SCORT suction units are designed for hospital crash carts, patient transport and emergency medical service. Battery condition is automatically monitored and visualized by indicator lights on the control panel. The battery should be charged to a dependable working charge in 6 to 8 hours when connected to the charging source. Suction power can be regulated when full power may be considered harmful to the patient. SSCOR suction units are designed to provide instant, effective suctioning, independent of external sources of power and can be pre-set to be activated immediately upon reaching the distressed patient. All controls are clearly labeled and easily accessible. SSCOR suction units are equipped with a disposable collection canister which features a bacterial filter to screen airborne particulates and a mechanical shut-off valve to prevent fluid overflow. S-SCORT suction units are powered by sealed lead acid batteries. Many factors can affect the life of a battery:

- Leaving a unit switched on after there is no longer enough power to run the pump can cause a battery to deep discharge. This can reduce the life of, or destroy the battery.
- Failing to charge a battery for an extended period of time will also cause the battery to go into deep discharge.
- Low temperatures may reduce the available capacity.
- High temperatures may cause deformation of the battery case and damage the battery.

Sealed lead acid batteries can easily be maintained to permit proper operation of the equipment. To protect the battery, after each procedure turn the unit off, put the unit on charge and always store the pump at room temperature. The only way to assure the battery has functional capacity, even if it is indicated the battery is fully charged, is to perform the weekly check suggested on page 8 of this operations manual.

Model 2314 Series

The S-SCORT new-Duet is a portable, 100V-240V AC constant suction device, with a 12V DC battery back-up. The battery is charged by an internal, DC dual mode battery charger. The charger monitors the battery, charges the battery only when necessary, shuts down the unit if battery is low and signals battery condition. A fully charged battery at full capacity will power the unit for 45 minutes ($\pm 10\%$).

Model 2310 Series

The S-SCORT VX-2 is a portable, 12V DC battery operated suction device for resuscitation emergencies in prehospital care. The battery is recharged by an internal, DC dual mode battery charger which is activated by the AC-DC converter or direct connection to the vehicle electrical system. The charger monitors the battery, charges the battery only when necessary, shuts down the unit if battery is low and signals battery condition. A fully charged battery at full capacity will power the unit for 45 minutes ($\pm 10\%$).

Model 2309 Series

The EVX is a portable, 12V DC battery operated suction device for resuscitation emergencies in prehospital care. The battery is recharged by direct connection to the vehicle, or an optional SSCOR fixed voltage charger (Model 2309 only). A fully charged battery at full capacity will power the unit for 45 minutes ($\pm 10\%$).

S-SCORT® new-Duet® Model 2314 Series - AC suction unit with battery back-up

S-SCORT® VX-2® Model 2310 Series - Battery operated portable suction pump

S-SCORT® EVX™ Model 2309 Series - Battery operated portable suction pump







US Patent Pending

ETL listed, conforms to UL 60601-1, IEC 60601-1, and EN 60601-1-2 and certified to





CAN/CSA STD C22.2 NO. 601.1-M.90, IPX4 per IEC 60529, EN1789:1999

©2007 S-SCORT, new-Duet, VX-2, HI-D and Big Stick are registered trademarks of SSCOR, Inc.

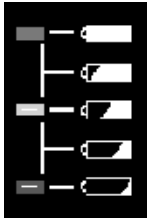

Description of Symbols - All Units

| <u>Symbol</u> | <u>Location</u> | <u>Meaning</u> |
|---|------------------|---|
|  | Serialized Label | Type B Equipment |
|  | Serialized Label | Separate Collection for Electronic Equipment |
|  | Serialized Label | Attention - Consult Accompanying Documents |
|  | Shipping Carton | Manufacturer |
|  | Shipping Carton | Date of Manufacture |
|  | Shipping Carton | Authorized Representative in the European Community |



Description of Symbols - Model 2314 Series and 2310 Series Only

| | | |
|---|---------------|----------------------------|
|  | Control Panel | Power Source Connected |
|  | Control Panel | Pump is On |
|  | Control Panel | Battery Level of Charge |
| | | Green LED = Full |
| | | Green / Yellow LED = High |
| | | Yellow LED = Half |
| | | Yellow / Red LED = Low |
| | | Red LED = Battery Depleted |
| | | Put unit back on charge |
|  | Control Panel | Push On / Push Off |

Description of Symbols - Model 2314 Series Only

| | | |
|---|------------------|-------------------------------------|
|  | Serialized Label | Class II Equipment Double Insulated |
| 100 - 240  | Serialized Label | Alternating Current (100-240V AC) |

Description of Symbols - Model 2309 Series Only

| | | |
|---|---------------|---------------------|
|  | Control Panel | On - Turn Pump On |
|  | Control Panel | Off - Turn Pump Off |

Getting Acquainted Model 2314 Series

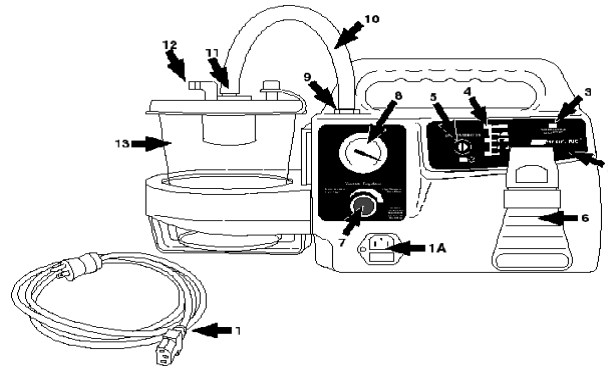

Getting Acquainted Model 2310 Series



Note: Converter and DC Cable not supplied with Model 2310B

Two Position Regulator
2310 & 2310B

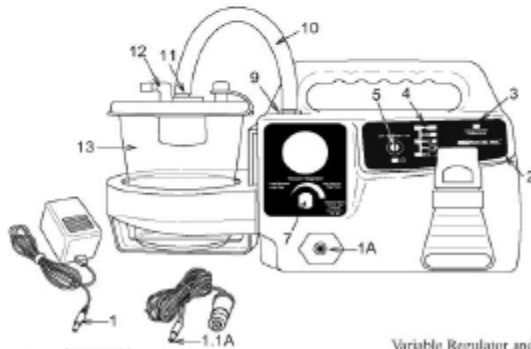

Note: Converter and DC Cable not supplied with Model 2310BV

Variable Regulator and Gauge
2310V & 2310BV

Getting Acquainted Model 2309 Series

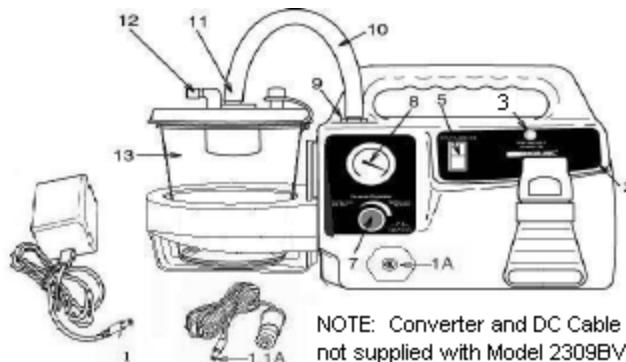

NOTE: Converter and DC Cable not supplied with Model 2309BV

Getting Acquainted - Model 2314 Series

Running the unit from AC Power

1. Connect the female plug on the AC power cord (1) to the facing side of the unit (1A).
2. Connect the male plug on the AC power cord (1) to a grounded wall receptacle.
3. Check the control panel (2). The “power source connected” orange LED (3) indicates a good connection to the AC power source. The battery condition indicators (4) show the charge level of the battery (See Description of Symbols page 4).
4. Press the ON/OFF switch (5) on the control panel to start the vacuum pump.

Getting Acquainted - Model 2314BV-230

CHARGING THE BATTERY USING THE 8323 CHARGING / RETENTION BRACKET:

Hard wire the charging cable from the Model 8323 Charging / Retention Bracket to the hot DC circuit (in front of the master switch). Make certain the circuit is properly fused according to appropriate vehicle standards. The vehicle electrical system will furnish power to both run the pump and charge the battery. The pump is powered by the vehicle current. See pages 16-17 for instructions to wire and mount the Charging / Retention Bracket.

All SSCOR suction units have a diode to prevent drawdown from the pump to the vehicle electrical system and a fuse to protect the pump from vehicle electrical surges. If your suction unit is wired to the vehicle battery via an automatic load switch power supply, be sure to use a filter in order to eliminate any voltage spikes.

BATTERY CHARGING VERIFICATION: Once the unit is connected to the charging source, check the control panel (2). The “power source connected” LED (3), when lit, shows a good connection and indicates the battery is charging.

Getting Acquainted - Model 2310 and 2309 Series

CHARGING THE BATTERY USING THE 8310 CHARGING / RETENTION

BRACKET: Hard wire the charging cable from the Model 8310 Charging / Retention Bracket to the hot DC circuit (in front of the master switch). Make certain the circuit is properly fused according to appropriate vehicle standards. The vehicle electrical system will furnish power to both run the pump and charge the battery. The pump is powered by the vehicle current. See pages 16-17 for instructions to wire and mount the Charging / Retention Bracket.

DC BATTERY CHARGING FROM VEHICLE: An active vehicle, running all around the clock, will do well to charge the suction unit from the vehicle's DC charging system. Hard wire the DC power cord to the DC electrical system of the vehicle on a properly fused line in front of the master switch. Connect the electrical line cord to the suction unit by securely attaching the charging plug (1.1A) into the receptacle (1A). This charging method is designed to keep the battery charging at all times. If the suction unit is operated while it is hooked up to the vehicle it will utilize the vehicle power and save its own battery for emergency use. All SSCOR suction units have a diode to prevent drawdown from the pump to the vehicle electrical system and a fuse to protect the pump from vehicle electrical surges. If your suction unit is wired to the vehicle battery via an automatic load switch power supply, be sure to use a filter in order to eliminate any voltage spikes.

Model 2310 Series - DC BATTERY CHARGING FROM AC POWER USING AC-DC CONVERTER: The 9Volt 1Amp AC Converter will not run the pump. If battery charging from AC power is required, connect the SSCOR AC-DC converter (1) to an AC outlet. The converter connects to the unit through the receptacle (1A) on the front panel. Do not attempt to run the pump with the AC converter attached to the pump. **Remove the AC converter connection from the pump prior to any suction procedure.**

Model 2309 Series - DC BATTERY CHARGING FROM AC POWER USING AC-DC CHARGER: The Fixed Voltage Charger (#80533) will not run the pump. If battery charging from AC power is required, connect the SSCOR AC-DC charger (1) to an AC outlet. The charger connects to the unit through the receptacle (1A) on the front panel.

BATTERY CHARGING VERIFICATION: Once the unit is connected to the charging source, check the control panel (2). The "power source connected" LED (3), when lit, shows a good connection and indicates the battery is charging.

Getting Acquainted - All Units

Running the unit from DC power

1. Disconnect the power cord (1) and press the ON/OFF switch (5) on the control panel to start the vacuum pump.
2. Check battery condition indicators (4) (Model 2314 and 2310 Series only).

Adjusting the vacuum level

Two Position Regulator Models

- Occlude patient tubing and push vacuum regulator (7A) to the stop (full vacuum). Observe vacuum depressing canister lid. Pull vacuum regulator out to the stop to reduce vacuum to -125mmHg. See Caution - Notice, page 2 number 9.

Variable Regulator Models

- Occlude patient tube and turn vacuum regulator (7) clockwise to the stop.
- Observe gauge (located above the vacuum regulator). The vacuum reading should rise to -300mmHg from zero in 3 seconds. It should max out at approximately ≥ -525 mmHg.
- Adjust the vacuum reading to your desired level.
- If the vacuum does not meet or exceed -525mmHg, check for a leak in the system i.e. tubing, barb connections or loose canister lid. Refer internal vacuum problems to qualified personnel.

After your test, reconnect the unit to the charging source; check the power light (3).

WEEKLY TEST - All Units

Run the following test weekly to ensure proper performance of the device

1. Confirm the power cord is supplying power to the device. Check the power indicator light on the control panel (3).
2. Remove the power cord and run the unit from its internal DC battery.
3. Check for vacuum by occluding the patient tube and set the vacuum regulator (7, 7A) to the maximum vacuum setting.
4. If applicable, observe the regulator gauge (8). The vacuum reading should rise to -300mmHg from zero in less than 3 seconds. It should max out at ≥ -525 mmHg. Un-occlude the patient tubing.
5. Allow the unit to run for 15 minutes on DC power. If the unit stops or slows during the 15 minutes, or if the battery condition indicators (4) begin to blink, it is possible the battery capacity has been depleted. It is time to replace the battery.
6. If the unit is still running at full power after 15 minutes, adjust the regulator to the desired setting, turn the device off and put it back on charge.

NOTE A: If the vacuum does not reach -525mmHg, check for a leak in the system i.e. vacuum tubing (10), barb connections (11,12) or loose canister lid (13). Refer internal vacuum problems to qualified personnel.

NOTE B: Reconnect the unit to the charging source as soon as possible after each use.

SPECIAL NOTICE - Model 2314 and 2310 Series

A blinking LED on the control panel indicates low battery capacity. This means the battery has been subjected to irreparable damage. REPLACE THE BATTERY!

General Specifications

CHARACTERISTICS

SPECIFICATIONS

| | |
|---|---|
| Size | 17"L x 9"H x 5.25"W (43.18cm L x 22.86cm H x 13.33cm W) |
| Weight | 10.5 lbs. (4.8Kg.) |
| Vacuum Pump | 12V DC oil-less diaphragm. Clinical Airflow >= 30LPM |
| Variable Regulator (7) | Controls negative pressure |
| Two Position Regulator (7A) | Controls negative pressure |
| Gauge (8) (If applicable) | Calibrated in mmHg. Color-coded. |
| Power Source: Battery (DC Power) | Rechargeable Sealed Lead Acid. 45 (±10%) minute running time at full capacity and fully charged. SSCOR part # 80635 (2314 and 2310 Series) SSCOR part #80638 (2309 Series) |
| Medical Switcher (AC Power) | 100V-240VAC, 47-63Hz |
| Model 2314 Series | Uses 1ea. 3A 250V fast acting fuse |
| Switch (5) - Model 2314 and 2310 Series | Off/Standby/On membrane switch |
| Switch (5) - Model 2309 Series | On/Off rocker switch |
| AC receptacle (1A) - Model 2314 Series | Uses (2) 2.5A 250V fast acting fuses |
| Collection Canister (13) | 1200cc/ml SSCOR part #48041 |
| Patient tubing | Vinyl tubing 9/32"ID x 72"L (7.1mm ID x 182.88 cm L) SSCOR part #43200 |
| Suction Tip | HI-D® "Big Stick®" SSCOR part #44241C |

Trouble Shooting

WARNING: DO NOT ATTEMPT TO SERVICE THIS EQUIPMENT
IF YOU ARE NOT A QUALIFIED MEDICAL REPAIR TECHNICIAN

| <u>Problem</u> | <u>Possible Cause</u> | <u>Corrective Action</u> |
|--|---|---|
| Power source connected LED not lit | Fuse blown Molex connections disconnected. Power cord disconnected | Replace fuse in power supply, input receptacle, or wiring harness Open unit and check to see Molex connections are secure. Reconnect cord |
| Does not function when switch is turned on | Battery discharged Molex connections disconnected. | Reconnect to charging source Open unit and check to see Molex connections are secure. |
| Blinking LED | Low battery capacity | Replace battery |
| No suction when pump is running | Vacuum line (10) loose Canister (13) defective Canister lid (13) loose Catheter thumb vent is open Debris has collected in the pump | Tighten vacuum line Replace canister Tighten canister lid Occlude thumb vent Refer to maintenance section |

Internal Access for Electrical and Pneumatics

WARNING: DO NOT ATTEMPT TO SERVICE THIS EQUIPMENT IF YOU ARE NOT A QUALIFIED MEDICAL REPAIR TECHNICIAN

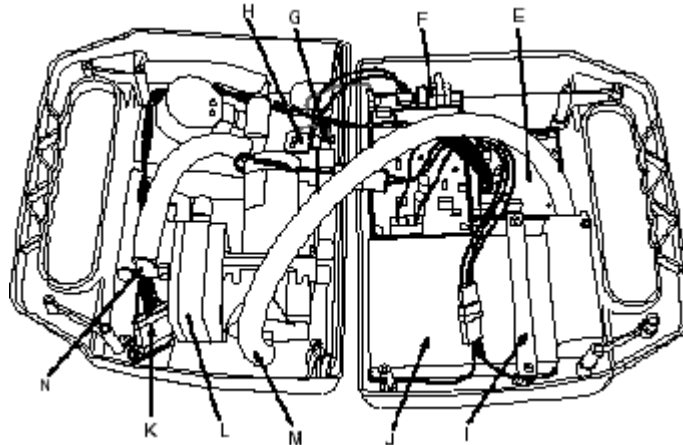

- (E) PC Board-Electrical Circuits (Internal Dual Mode Battery Charger - Model 2314 and 2310 series only). Do not attempt to service the PC Board. Return to SSCOR or authorized service center for service.
- (F) Power Supply (Medical Switcher Model 2314 Series only) Do not attempt to service the Power Supply. Return to SSCOR or authorized service center for service.
- (G) Functional ground (Model 2314 Series only).
- (H) AC receptacle. Two 250V-2.5A fuses are in the receptacle fuse drawer. (Model 2314 Series only)
- (I) Battery Bracket
- (J) Battery, 12V, Sealed Lead Acid
- (K) Wiring connection to the control panel (Model 2314 Series only)
- (L) Vacuum pump. Return to SSCOR or authorized service center for service. Do not attempt to service the vacuum pump.
- (M) Exhaust barb
- (N) Vacuum barb

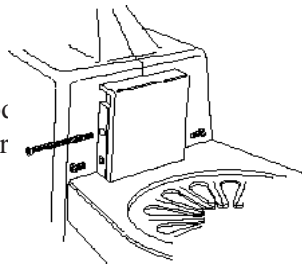

TO REMOVE CANISTER HOLDER:

Remove one 4" screw and two set screws on the canister bracket. Lift canister holder up and out of the main chassis.

TO OPEN/CLOSE THE UNIT:

Clamshell design enables access to components. All 6-32 phillips head fastening screws are located in back of the unit.

REMOVE MAIN CHASSIS SCREWS

- (A) 1 screw under the canister holder
- (B) 2 screws in the back of the handle
- (B) 3 screws in the back of the main chassis.
- (C) It should not be necessary to open the exhaust door unless fluids have entered the system.

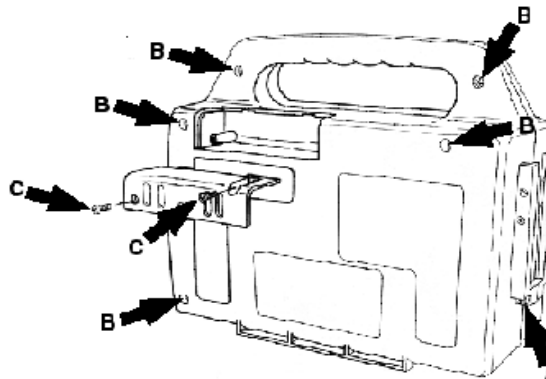

Warranty

SSCOR warrants that each new product is free from defects in material and workmanship under normal use and service for a period of one year from date of purchase. If returned to SSCOR, we will arrange for repairs or replacement within the terms of the warranty. The product should be decontaminated and returned properly packaged and postage prepaid. Loss or damage in transit to the factory shall be at the purchaser's risk. Please call 800-434-5211 or international +1 818-504-4054 for return authorization or for the location of an authorized repair center. Loss or damage in return shipment from SSCOR shall be at the purchaser's risk.

The warranty shall not apply to any SSCOR product which has been repaired by anyone other than an authorized SSCOR representative, or altered in any way so as, in SSCOR's judgment, to affect its safety or efficacy, nor which has been subject to misuse, negligence, or accident, nor which has had the serial number altered, effaced or removed.

Neither shall this warranty apply to any SSCOR product which has been connected otherwise than in accordance with the instructions furnished by SSCOR.

This warranty is in lieu of all other warranties expressed or implied and of all other obligations or liabilities on SSCOR's part, and SSCOR neither assumes, nor authorizes any representative or other persons to assume for it, any other liability in connection with the sale of SSCOR products.

This warranty gives you specific legal rights and you may also have other rights that vary from jurisdiction to jurisdiction. For countries where minimum warranty terms are determined by statute, the warranty term is the longer of the statutory period or the term listed above.

Batteries, disposable items including collection canisters, patient tubing and catheters are excluded from this warranty.

Model 2314 Series Battery Replacement Policy

SSCOR will replace any S-SCORT® new-Duet® battery which fails to operate the pump to specifications for a period of three years from the date of purchase. Verify the condition of the battery per the weekly checklist on Page 8 in this Operations Manual.

S-SCORT VX-2 with Charging / Retention Bracket Battery Replacement Policy

If the S-SCORT VX-2® is purchased with the Charging / Retention Bracket, SSCOR will replace the battery if the battery fails to operate the pump to specifications for a period of three years from the date of purchase. Verify the pump runs to specifications as per the instructions on page 8 in this Operations Manual.

Maintenance

Preventive Care

Observe the following maintenance routine to ensure readiness at any time:

1. When the SSCOR aspirator is not in use, keep batteries on continuous charge.
2. Test the SSCOR aspirator at regular intervals; See page 8.
3. Make sure the SSCOR aspirator is always clean and ready for use.
4. If the procedure produced an excessive quantity of fluids, check the vacuum line (10) for evidence of moisture. If the vacuum line between the pump and canister is moist, it is possible that fluids have reached the vacuum pump. See “Decontamination Instructions (See pages 12 and 13).
5. If the Medical Switcher Power Supply (F) appears defective, return the unit to the factory for repair. Do not attempt to repair the Medical Switcher Power Supply.
6. If the Internal Dual Mode Battery Charger (E) appears defective, return the unit to the factory for repair. Do not attempt to repair the Internal Dual Mode Battery Charger.
7. If the vacuum pump (L) appears defective, return the unit to the factory for repair. Do not attempt to repair the vacuum pump.
8. Sanitation and Decontamination Instructions: See pages 12 and 13.
9. For technical assistance, call (800) 434-5211 or international +1 818-504-4054.

Note: No part requires lubrication and lubricants should not be used.

Sanitation

As soon as possible after use, the single use disposable canister, patient tubing and catheter should be discarded according to local / regional / national requirements for the disposal of hazardous waste materials. Clean the exterior of the SSCOR suction unit using a mild detergent and clear water by dampening a clean lint free cloth. Rinse using clear water and another damp clean lint free cloth to remove any detergent residue.

NOTE: The hydrophobic filter in the canister helps to ensure that no moisture or particulate matter reaches the inside of the device. When fluids fill the canister, the positive (mechanical float) shutoff valve closes immediately, shutting the vacuum port off so as to prevent fluid from contacting the pump. The filter has been tested by the manufacturer (Bemis) to screen out aerosolized microorganisms and particulate matter at a bacterial efficiency rating of 99.99% DOP. The canister also has sidewall gradation marks starting at 100 ml/cc and at every 50 ml/cc up to 1200 ml/cc indicating the fill level of the canister.

In the unlikely event that fluids may have reached the vacuum pump, read the decontamination section. Your engineering department will have to open the unit to check the condition of the pump.

In the unlikely event that fluids may have reached the exhaust filter, remove the two screws holding the filter door in place (see page 10), remove the soiled filter and replace with new filter (SSCOR part number 90160).

Do not reuse any single use disposable parts; do not submerge the device into any liquid, this will void the warranty and cause the device to malfunction.

Maintenance

Decontamination

Use personal protective equipment such as gloves, a smock, and face and eye protection when handling units that are suspected to be contaminated.

Part

Cleaning and Disinfecting

| | |
|---------------------|---|
| Collection Canister | Disposable item, re-use not permitted. Use new canister for each patient. |
| Patient Tubing | Disposable item, re-use not permitted. Use new patient tubing for each patient. |
| HI-D® Stick | Disposable item, re-use not permitted. Use new HI-D Stick for each patient. |
| Vacuum Pump | Wipe with damp cloth or disinfectant wipe. Sterilization not permitted. Vacuum pump should be replaced if contaminated. |
| PC Board | Sterilization not permitted. PC Board should be replaced if contaminated. |
| Plastic Chassis | Wipe with damp cloth or disinfectant wipe. Sterilization not permitted. |

Caution: Disconnect the unit from any power source prior to cleaning the unit.

Disinfect the unit using a mild surface disinfectant, such as a 10:1 mixture of water and bleach. The unit is designed to suction contaminated fluids, which should be removed from the system immediately after use. Your engineering department will have to open the unit to check the condition of the pump. When cleaning the interior of the chassis, disconnect the battery from the PC Board to prevent damaging the PC Board. The only foreseeable way fluids may reach the vacuum pump is the filter in the canister has been compromised or bypassed.

For technical assistance, call (800) 434-5211 or +1 (818) 504-4054.

DECLARATION OF CONFORMITY

SSCOR, Incorporated
11064 Randall Street
Sun Valley, CA 91352
United States of America
Tel: +1 (818) 504-4054
Fax: +1 (818) 504-6032

Type of Equipment: Portable Powered Suction Pump

Model Name and Type: S-SCORT...Jr.® Quickdraw® Model 2400 Series
S-SCORT® new-Duet® Model 2314 Series
S-SCORT® VX-2® Model 2310 Series
S-SCORT® EVX™ Model 2309 Series

We herewith declare that the above mentioned product meets with the following requirements of the EC Directive concerning Medical Devices – 93/42/EEC and the Swedish regulation LVFS 2003:11

| | |
|--|--|
| Safety: | IEC/EN 60601-1: 1990 With A1 & A12:1993, A2:1995 & A13:1996 |
| EMC: | IEC/EN 60601-1-2: 2001 |
| Safety Requirements - Medical Suction Unit | ISO 10079-1 |
| Medical Vehicles and their Equipment | EN 1789: 1999 |
| Degrees of Protection Provided by Enclosure | IPX4 |
| Classification | Class IIa |
| Rules of Classification | Annex IX, Rule 11 |
| Annex used for CE Declaration | Annex V & Annex VI |
| Notified Body | INTERTEK SEMKO, AB |

Signature, Date:



July 4, 2006

Name:

Sam D. Say

Title:

President

Authorized European Representative

Emergo Europe
Molenstraat 15
2513 BH, The Hague
The Netherlands
Tel: (+31) 70 345 8570
Fax: (+31) 70 346 7299

Retention Bracket Mounting Instructions S-SCORT® new-Duet®

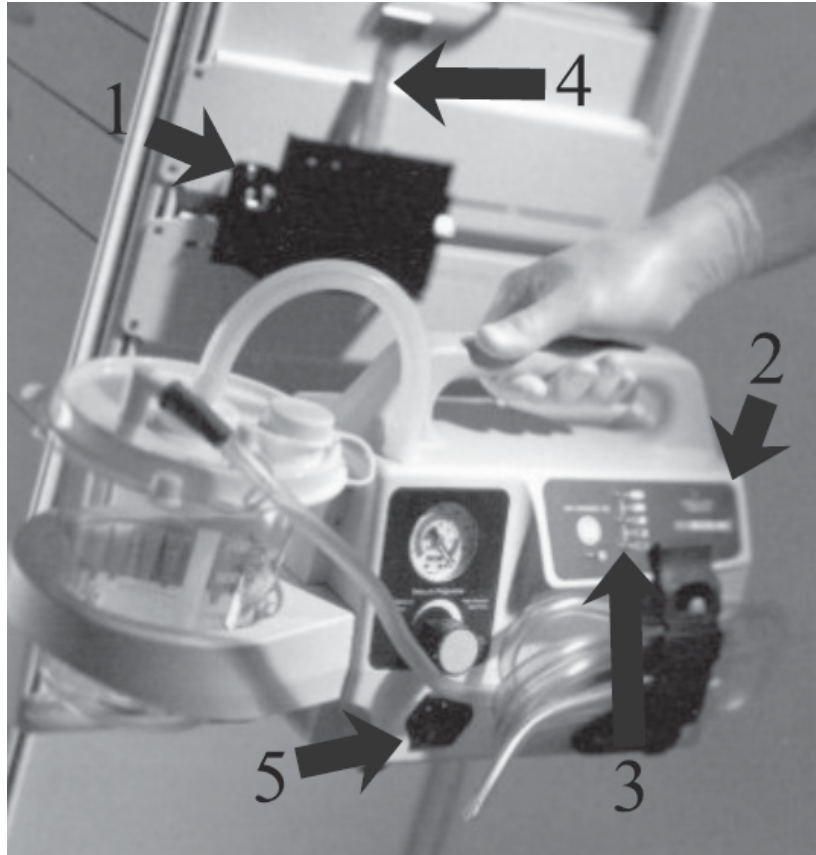

Mount the retention bracket to a suitable safe mounting surface using the four holes on the side of the shelf (1). Mount the retention bracket so the new-Duet suction unit can be released from the bracket easily and there is enough room to work the handle (4). The control panel (2) should be easily viewed and the battery condition LED's (3) visible when the unit (5) is connected to a grounded hospital receptacle. When placing the suction unit into the retention bracket, be sure the unit snaps into the bracket and is securely held in place.

Charging/Retention Bracket Mounting Instructions

The Model 8310 and 8323 Charging/Retention bracket can be mounted by the base or mounted vertically in order to hold the S-SCORT portable suction unit. Mount the retention bracket to a surface that is sufficiently strong to hold the charging / retention bracket and the S-SCORT® suction unit securely in accordance with CEN1789 Medical Vehicles and their Equipment - Road Vehicles. Be sure to mount the unit so the switch on the control panel is visible and accessible to the user. The unit is shipped ready to be mounted vertically, but if that does not fit your requirements, you can easily modify the unit to mount it by the base.

Vertical Mount

Remove the four ¼-20 x 1-1/2” hex head screws from the hardware packet. Use the Mounting Template (page 17) of the Operation Instructions and Maintenance Manual to mark the hole placement for a vertical mount. Use a 5/16” drill. Coat the screws with Loctite® (not supplied) before securing the Charging/Retention Bracket. Put the four 1-1/2” screws through the holes in the charging bracket. Attach the washers and nuts to the screws to secure the Charging/Retention bracket in place.

Base Mount (part #8314-7)

Use the Mounting Template (page 17) of the Operation Instructions and Maintenance Manual to mark the hole placement for a base mount. Use a 5/16” drill. Remove the hardware from the hardware packet. Coat the screws with Loctite (not supplied) and place the screws through the bottom of the Bracket, Retention - Counter Mount (#8314-7) and through the holes you have drilled. Attach the washers and nuts to secure the Bracket, Retention - Counter Mount (#8314-7) in place. Mount the charging bracket to the base mount (#8314-7) using the hardware in the hardware packet. Coat the screws with Loctite (not supplied) before securing the Charging/Retention Bracket to the base mount bracket (#8314-7).

Electrical

Hard wire the Charging / Retention Bracket to the DC Electrical System of the vehicle in front of the master switch. Make certain the circuit is properly fused according to appropriate vehicle standards.

Retention Bracket Mounting Template

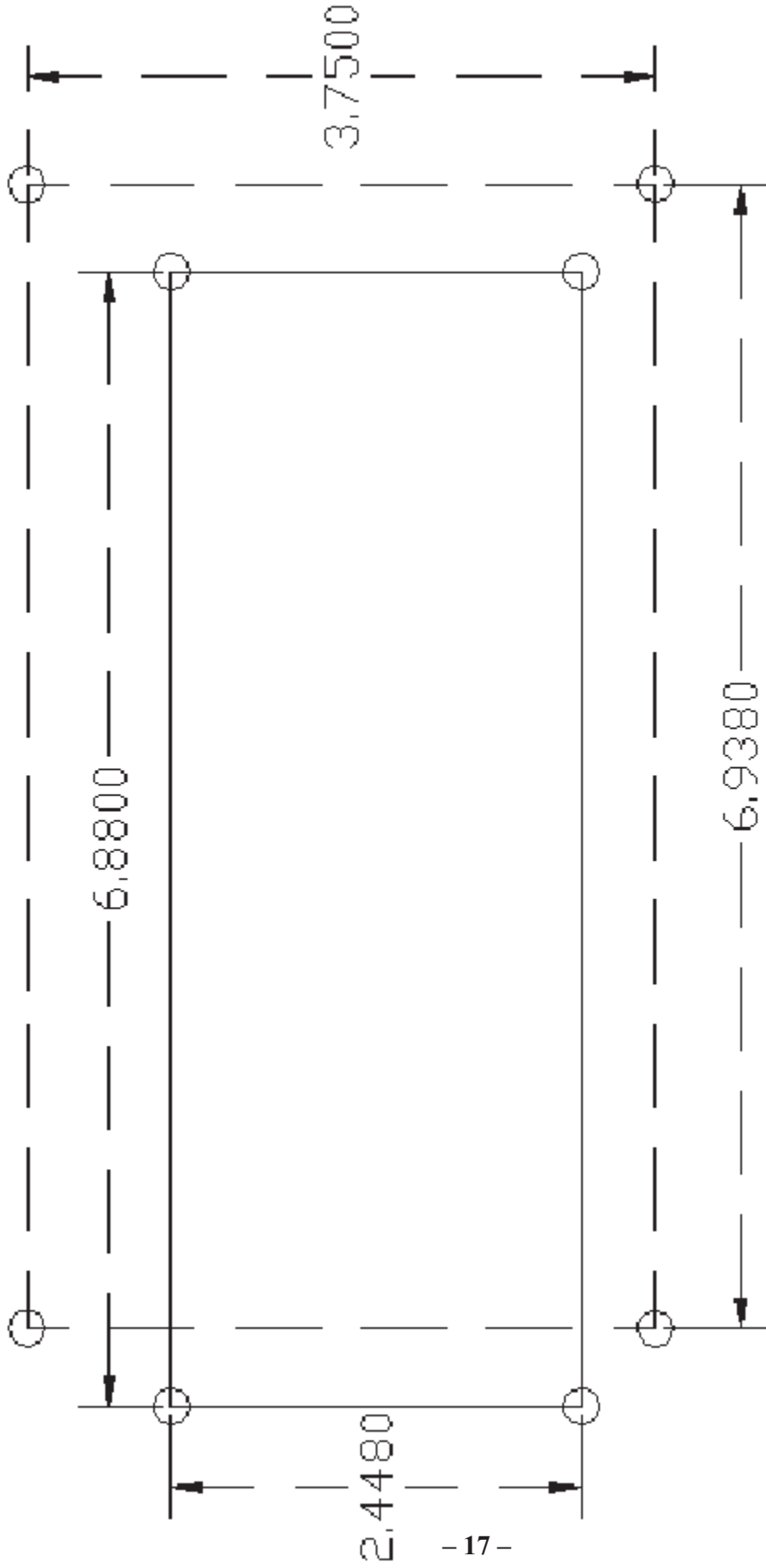

Vertical Mount = solid lines

Base Mount (8314-7) = dashed lines

Please Note - Template size may vary on different printers. Make sure your holes are marked per the dimensions on the template. Note: All dimensions in inches